



**User Manual**  
**SST1 & SST1E**  
**2 & 3 Year Model**  
**Single Gas Device**

SST1-SST1E-2-3-YEAR-MAN-ENG-v1.4D4F

22.04.2026

# Contents

## Safety Information - Read First

### 1. Introduction

- [1.1 SST1/SST1E 2 and 3-Year Model Product Description](#)
- [1.2 Configuration Mobile Application](#)
- [1.3 Sensor Poisons and Contaminants](#)

### 2. Overview of Detector

- [2.1 How to Tap a Unit](#)
- [2.2 Overview of the SST1](#)
- [2.3 Overview of the SST1E](#)
- [2.4 Display Elements of the SST1/SST1E](#)
- [2.5 Pushbutton](#)

### 3. Activating the Detector

- [3.1 Start-up Process](#)
- [3.2 Normal Operating Detector Mode](#)
- [3.3 Operating Life Detector Mode](#)
- [3.4 45 Days or Less Remaining](#)
- [3.5 24 Hours or Less Remaining](#)
- [3.6 End of Operating Life](#)

### 4. Alarms Indicators and Warnings

- [4.1 Low Alarm](#)
- [4.2 High Alarm](#)
- [4.3 Over-Limit Alarms](#)
- [4.4 Under-Limit Alarms](#)
- [4.5 Factory Alarm Setpoints](#)
- [4.6 Compliance and Non-Compliance](#)
- [4.7 Compliance Interval Exceeded](#)
- [4.8 Calibration Interval Exceeded](#)
- [4.9 Bump Test Interval Exceeded](#)
- [4.10 Alarm Occurred](#)
- [4.11 Zero the Sensor](#)
- [4.12 Automatic Zero Reminder for O<sub>2</sub> Models](#)
- [4.13 Zero Procedure](#)

### 5. User Menu

- [5.1 Peak Reading](#)
- [5.2 Real-time Clock](#)
- [5.3 Low Alarm](#)
- [5.4 High Alarm](#)

[5.5 Clear Peak](#)

### 6. Communicating With the SST1/SST1E

- [6.1 Communicating With the SST1/SST1E in Hibernation](#)

### 7. WatchGas Device Link App

- [7.1 WatchGas Device Link App Main Screen](#)
- [7.2 WatchGas Device Link App Assign/Unassign Function](#)
- [7.3 WatchGas Device Link App Single Device Setup](#)
- [7.4 WatchGas Device Link App Saved Configurations](#)
- [7.5 WatchGas Device Link App Unassign](#)
- [7.6 WatchGas Device Link App Hibernation](#)
- [7.7 WatchGas Device Link App Maintenance](#)
- [7.8 Firmware Update](#)

### 8. Bump Test and Calibration

- [8.1 Manual Bump Test](#)
- [8.2 Manual Calibration](#)

### 9. Logs

- [9.1 Event Logs](#)
- [9.2 Downloading Event Logs](#)
- [9.3 IOELV and Daily Peaks](#)
- [9.4 Changelogs](#)

### 10. Firmware Upgrade

### 11. Troubleshooting

### 12. Failure Codes

### 13. Unlocking the SST1 Detector

[13.1 Unlock](#)  
[13.2 Reset Fault](#)

## **14. SST1 Spare Parts and Accessories Lists**

[14.1 Detector Accessories – External Filter](#)

## **15. SST1/SST1E Maintenance**

[15.1 Detector Maintenance – Battery Replacement](#)  
[15.2 Detector Maintenance – Internal Filter Replacement](#)  
[15.3 Detector Maintenance – Sensor Replacement](#)

## **16. Certifications and Approvals**

## **17. Contact Details**

## Safety Information - Read First

To ensure personal safety, read **Warning** and the **Cautions** before using the detector.

The SST1/SST1E Gas Detectors are personal life safety devices designed to detect the presence of certain toxic gases. The accuracy of ambient gas reading(s) is dependent upon factors such as accuracy of the calibration gas standard used for calibration and frequency of calibration. For safety reasons, users need to be properly trained in the use of the equipment and appropriate actions in the event of an alarm condition.

Use the detector only as specified in this user's manual and the operator's manual, otherwise the usage and protection provided by the detector may be impaired.

Read the **Warning** and **Cautions** below before using the detector.

### Warning

- Do not attempt to replace the internal components. This will void the intrinsic safety rating and will void the warranty of the product. Unless replaced with original WatchGas parts.
- Periodically test the response of the sensor by exposing the detector to a target gas concentration that exceeds the alarm setpoint. Manually verify that the audible, vibration and visual alarms are activated.
- Ensure the monitor is switched on, sensor and audible port are clean prior to use.

### Cautions

- All inspection should be performed in a clean and hazardous-free environment.
- The detector can be cleaned with a soft damp cloth using a neutral cleaner (e.g ACL Staticide). **NOTE:** Do not use solvents, soaps, or polishes.
- Bump test the response of the sensor by exposing the detector to a target gas concentration that exceeds the alarm setpoint. Manually verify that the audible, vibration and visual alarms are activated.
- This product is a gas detector, not a measuring device.
- Ensure the monitor is switched on, sensor and audible port are clean prior to use.
- For optimal performance, periodically zero the sensor in a normal atmosphere (20.9% v/v O<sub>2</sub>) that is free of hazardous gas.
- Activate the detector one year after purchase at the latest, or validate battery function.
- The equipment is intended for use in hazardous atmosphere in air with normal oxygen content not exceeding 21% v/v (typical value).
- The end-user shall contact the equipment manufacturer if the antistatic film applied on the equipment is damaged.
- The internal battery is non-replaceable. The internals must not be accessed by the end-user by any means.

# 1. Introduction

## 1.1 SST1/SST1E 2 and 3-Year Model Product Description

The SST1/SST1E single gas detectors provides up to three years maintenance-free operation and is available in H<sub>2</sub>S, SO<sub>2</sub>, CO, or O<sub>2</sub> models. With its simple design it is perfect for users that are looking for ultimate protection while being easy to use, durable, and cost-effective. Simply turn on the device and it runs 24/7 for 2 to 3 years (based on 2 minutes of alarm per day for all models **except the SST1E Oxygen**, whose battery run time will be 1 to 1.5 years, depending on the alarm) — no calibration, no battery replacement, no charging, and no stress.

The SST1 utilizes a Polymer-based sensor, whereas the SST1E utilizes a gel-based Electrochemical sensor.

The device is easy to use and reduces the need for extensive training. The SST1/SST1E, coupled with the SST Dock, allows for the fastest bump testing on the market and makes fleet management extremely simple.

## 1.2 Configuration Mobile Application

The detector is configured through the WatchGas Device Link App. The WatchGas Device Link App can be downloaded from [Google Play](#) and the [App Store](#), or by scanning the QR code beneath.



## 1.3 Sensor Poisons and Contaminants

Several cleaners, solvents, and lubricants can contaminate and cause permanent damage to the SST1/SST1E sensors. Before using cleaners, solvents, and lubricants in close proximity to the SST1/SST1E detector sensors, read the following cautions and refer to the lists below.

### Caution

Use only the following WatchGas recommended products and procedures:

- Use water-based cleaners.
- Use non-alcohol-based cleaners.
- Clean the exterior of the detector with a soft, damp cloth.
- Do not use soaps, polishes, or solvents.

Below are common products **to avoid** using around sensors:

#### 1. Cleaners and Lubricants:

- Brake cleaners
- Lubricants
- Rust inhibitors
- Window and glass cleaners
- Dishsoaps
- Citrus-based cleaners
- Alcohol-based cleaners
- Hand sanitizers
- Anionic detergents
- Methanol (fuels and antifreezes)

#### 2. Silicones:

- Silicone cleaners and protectants
- Silicone-based adhesives, sealants, and gels
- Hand/body and medicinal creams containing silicone
- Tissues containing silicone
- Mold releasing agents
- Polishes

#### 3. Aerosols:

- Bug repellents and sprays
- Lubricants
- Rust inhibitors
- Window cleaners

## 2. Overview of Detector

Configuration of the SST Range products, including the SST1/SST1E, is done with the WatchGas Device Link App. The app can be downloaded from [Google Play](#) and the [App Store](#), or by scanning the appropriate QR code in [Section 1.2](#). You can read more about the app [on our website](#).



For detailed information on the WatchGas Device Link App, refer to the **WatchGas Device Link App manual**.

### 2.1 How to Tap a Unit

Ensure that your phone has NFC capability.

The NFC is located on the back of the detector - just below the alligator clip.

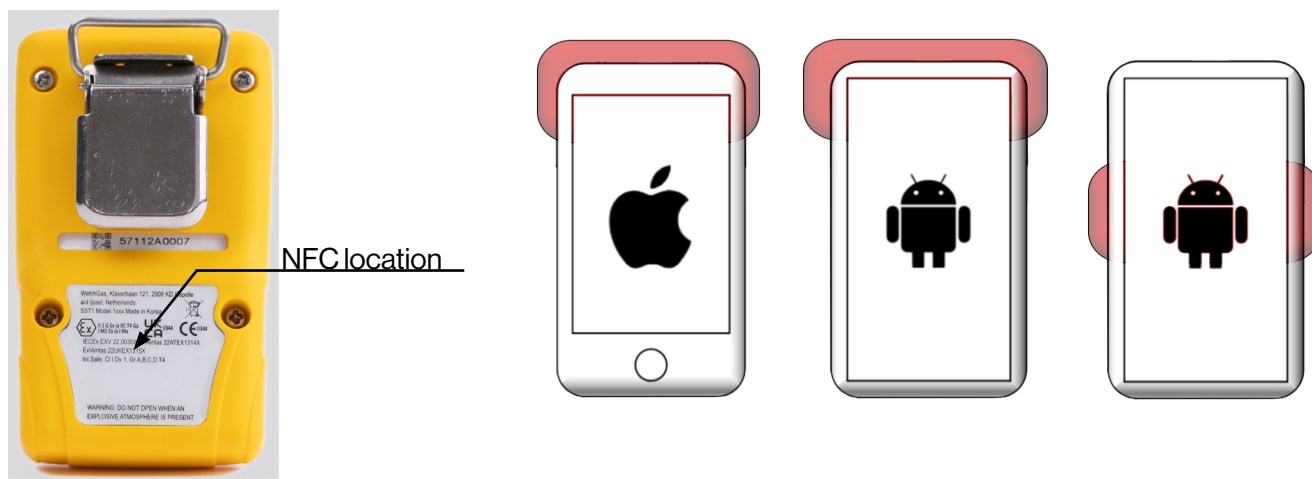

Locate the NFC on your phone (normal locations shown above). The phone gives a clear visual indication when the NFC connects.

## 2.2 Overview of the SST1

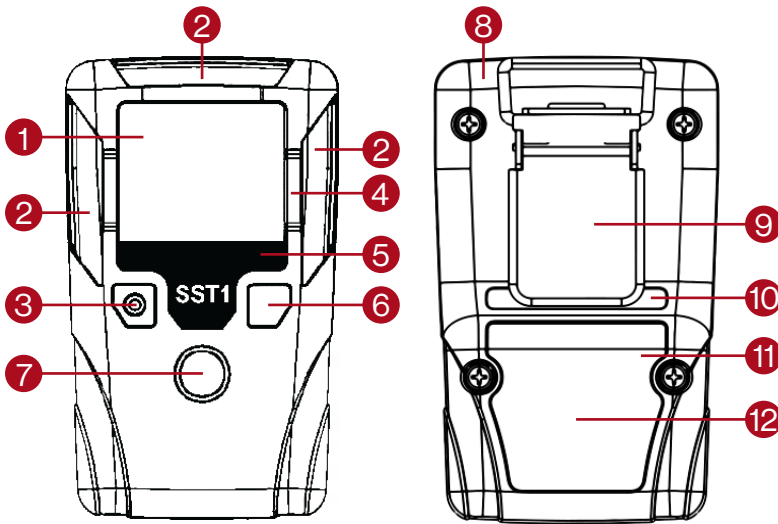

Figure 6. Overview of the SST1

Symbols	Description
1	Liquid crystal display (LCD)
2	Visual alarm bars
3	Audiable alarm
4	Screen scratch protectors
5	Gas identification
6	Pushbutton
7	Sensor
8	Housing
9	Alligator Clip
10	Serial number
11	NFC antenna
12	Certification label

Table 1. Overview of the SST1

## 2.3 Overview of the SST1E

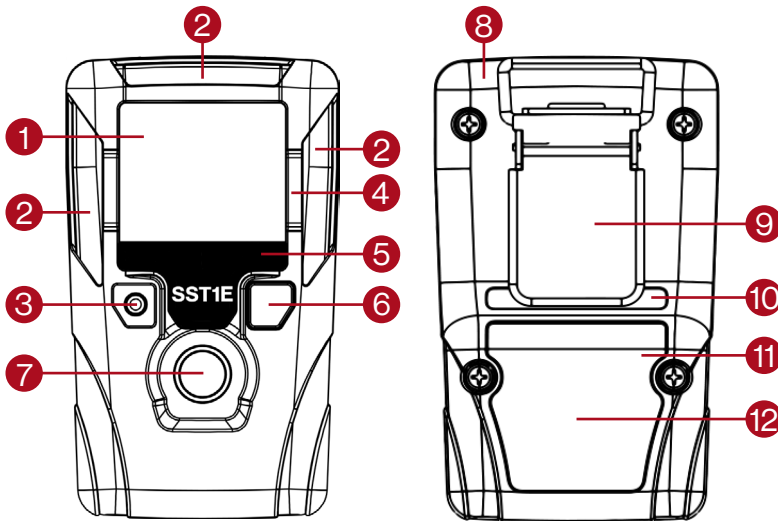

Figure 7. Overview of the SST1E

Symbols	Description
1	Liquid crystal display (LCD)
2	Visual alarm bars
3	Audiable alarm
4	Screen scratch protectors
5	Gas identification
6	Pushbutton
7	Sensor
8	Housing
9	Alligator Clip
10	Serial number
11	NFC antenna
12	Certification label

Table 2. Overview of the SST1E

## 2.4 Display Elements of the SST1/SST1E











Symbols	Description
<b>ALARMS</b>	
	Alarm Notification
<i>LOW</i>	Low Alarm
<i>HIGH</i>	High Alarm
STEL	Short Term Exposure Alarm
TWA	Time Weighted Average Alarm
<b>SENSOR EXAMPLES</b>	
<b>H<sub>2</sub>S</b>	Hydrogen sulfide Sensor
<b>SO<sub>2</sub></b>	Sulfur dioxide Sensor
<b>CO</b>	Carbon monoxide Sensor
<b>O<sub>2</sub></b>	Oxygen Sensor
<b>WARNINGS</b>	
	Unit Expired / Circuit Fault
	Compliance / Diagnostic Failure
	Peak alarm seen last 24 hours
<b>INFORMATION</b>	
	Product Compliant
	Product Non-Compliant
<b>CAL</b>	Calibration Required
<b>BUMP</b>	Bump Required
	NFC in Communication
	Button prompt
<b>UNIT OF MEASUREMENT</b>	
	Percent Volume (O <sub>2</sub> )
<b>PPM</b>	Parts Per Million (H <sub>2</sub> S / CO / SO <sub>2</sub> )
<b>MG/M3</b>	Milligrams per Cubic Meter
	Real time clock
<b>MM</b>	Months remaining on Device
<b>DD</b>	Days remaining on Device

Table 3. SST1/SST1E Display Elements

## 2.5 Pushbutton



**To activate the SST1/SST1E detector**, press and hold the pushbutton (the big yellow button on the front of the device) and a 5 second countdown will start. Keep pressing the pushbutton until the countdown ends, after which the detector will then turn on.

**To view the peak (maximum) readings**, press the pushbutton twice.

**To clear the peak readings**, press the pushbutton when the LCD displays CLR.

**To activate the NFC**, press the pushbutton for 1,5 seconds until a single beep and the NFC  icon is active.

### 3. Activating the Detector

#### Caution

Only activate the detector in a fresh air environment (with 20.9% oxygen concentration) and in a safe area that is free of any hazardous gases.

#### 3.1. Start-Up Process

Press and hold the pushbutton on the SST1/SST1E device until a 5-second countdown appears on the display. Continue holding the button until the countdown reaches zero.

When the countdown is complete, the LCD screen and LEDs will cycle on and off.

The alarm setpoints will then be visibly displayed on the LCD screen.

A countdown for the sensor warm-up will start, with a duration of 20 seconds for Toxic sensors (CO, other gasses) and 2550 seconds (42.5 minutes) for Oxygen sensors, due to it being a biased sensor.

The SST1 detector will then activate its LCD display, LEDs, buzzer, vibrational motor, and internal diagnostics.

Depending on the SST1 model, the detector will proceed to indicate its remaining operational life.

When the start-up has been completed, the detector will remain turned on. Turning the detector off is not possible by means of pressing the pushbutton on the SST1/SST1E device. To turn off the detector, refer to the [Hibernation section](#).

#### 3.2 Normal Operating Detector Mode

When the SST1/SST1E detector is operating in Detector Mode, the remaining lifetime will be prominently displayed on the LED screen. Simultaneously, the detected concentration of the gas will be continuously shown until any interruption occurs, such as a pushbutton action, a gas alarm triggering, or an error event.



#### 3.3 Operating Life Detector Mode

In Detector Mode, the LED will display the SST1/SST1E device's remaining operating life in months. The SST1/SST1E detector life is either 24 or 36 months, depending on the model.

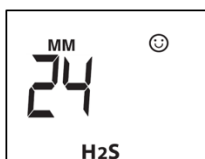

### 3.4 45 Days or Less Remaining

When the operating life countdown reaches 45 days or less before expiry, the SST1//SST1E's display format changes to show the remaining operating life in days. This countdown continues until it reaches 24 hours or less before expiry.

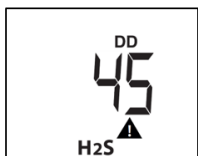

### 3.5 24 Hours or Less Remaining

When the operating life countdown reaches 24 hours or less before expiry, the SST1//SST1E's display format changes to show the remaining time in hours. Additionally, the warning icon, clock icon, non-compliance symbol, along with a brief audible/visual warning will be provided to alert the user to this.

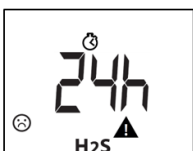

### 3.6 End of Operating Life

When the operating life countdown ends, the SST1//SST1E detector deactivates, and its safety functions are disabled. However, event logs can still be retrieved for a limited time after expiry. The "LOCK" warning message and non-compliance symbol will be displayed for up to 30 days after expiry to ensure continued awareness of the expired status. Re-activation is allowed under some circumstances, refer to the [Unlocking the SST1 Detector section](#).

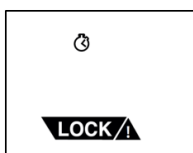

## 4. Alarms Indicators and Warnings

A gas alarm is triggered when the sensor detects a gas concentration surpassing the predefined alarm setpoints. The alarm remains active until the gas concentration returns to a safe level.

**NOTE:** battery life decreases rapidly during alarm conditions due to heightened power consumption.

### 4.1 Low Alarm

When the gas concentration exceeds the **Low alarm setpoint** it will display LOW and produce the alarm as per below (1x per second):

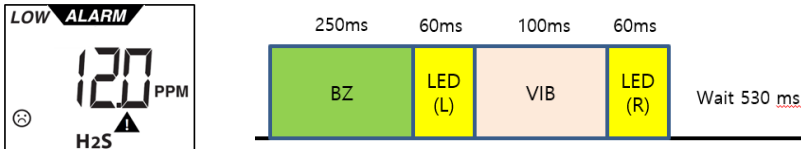

### 4.2 High Alarm

When the gas concentration exceeds the **High alarm setpoint** it will display HIGH and produce the alarm as per below (2x per second):

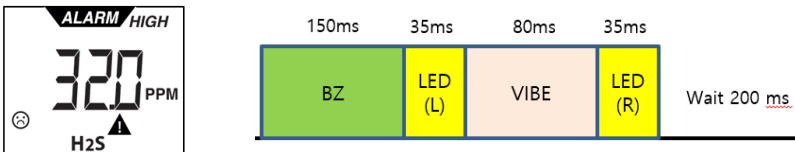

### 4.3 Over-Limit Alarms

When the gas concentration exceeds the sensor range it will display OL and produce the alarm as per below (2x per second):

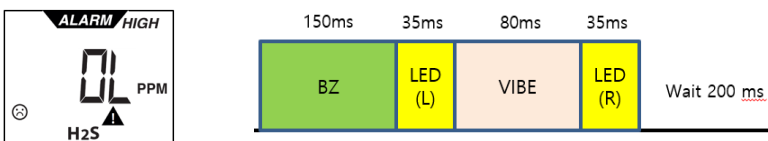

### 4.4 Under-Limit Alarms

When the gas concentration exceeds the sensor range it will display -OL and produce the alarm as per below (1x per second):

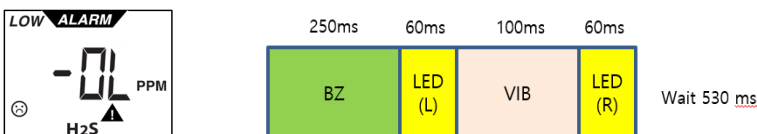

## 4.5 Factory Alarm Setpoints

**NOTE:** Standard factory alarm setpoints may vary by region.

Gas	Range	Low	High
SST1 H <sub>2</sub> S	0 - 500 ppm	10 ppm	15 ppm
SST1E H <sub>2</sub> S	0 - 300 ppm	10 ppm	15 ppm
SST1 CO	0 - 2000 ppm	35 ppm	200 ppm
SST1E CO	0 - 1500 ppm	35 ppm	200 ppm
SST1 SO <sub>2</sub>	0 - 100 ppm	5 ppm	10 ppm
SST1E SO <sub>2</sub>	0 - 40 ppm	5 ppm	10 ppm
SST1 O <sub>2</sub>	0 - 25 %	19.5% Vol	23.5% Vol
SST1E O <sub>2</sub>	0 - 25 %	19.5% Vol	23.5% Vol

**Table 4.** Factory Alarm Setpoints

## 4.6 Compliance and Non-Compliance

The SST1/SST1E will indicate device compliance by showing the happy smiley icon (☺), and flash the green compliance LED every 5 min, if enabled. The detector will show as compliant when below items are true:

- No active gas alarm
- No gas alarm occurred in last 24 hours
- No faults, failed calibration or failed bump test
- Calibration interval not exceeded (if enabled)
- Bump test interval not exceeded (if enabled)
- Compliance interval not exceeded (if enabled)
- Remaining lifetime more than 24 hours (Detector mode only)



The detector will indicate non-compliance, by means of indicating the sad smiley (☹), showing the ▲ symbol, and flashing its red LEDs 2x per 30 seconds if one or more of the below situations.

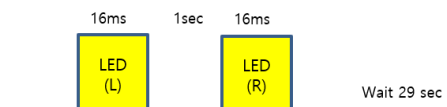

## 4.7 Compliance Interval Exceeded

If enabled, the compliance interval serves to remind users to regularly connect the SST1/SST1E detector to a WatchGas Device Link App, Compliance Kiosk, or SST Dock. When the compliance interval has been exceeded, the detector will indicate non-compliance by displaying the ▲ icon.

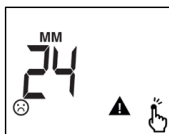

## 4.8 Calibration Interval Exceeded

If enabled, the calibration interval is designed to prompt users to conduct an SST1/SST1E detector calibration. Upon exceeding the calibration interval, non-compliance indicators will be displayed, accompanied by the CAL icon in the lower left corner.

A successful calibration (either manual, or by using the SST Dock) will reset the calibration interval and clear non-compliance.



## 4.9 Bump Test Interval Exceeded

The bump test interval is designed to prompt users to conduct an SST1/SST1E detector calibration. Upon surpassing the bump test interval, non-compliance indicators will be displayed, accompanied by the BUMP icon in the lower left corner.

A successful bump test or calibration (either manual, or by using the SST Dock) will reset the bump test interval.

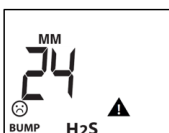

## 4.10 Alarm Occurred

The peak readings symbol is displayed when the sensor is exposed to a gas concentration that exceeds the alarm setpoints. It is no longer displayed when more than 24 hours have passed since the last alarm, when the SST1/SST1E detector is connected to a Compliance Kiosk or WatchGas Device Link App, or when a successful bump test/calibration is performed via an SST Dock, or manually.

The highest peak reading can be displayed on the SST1/SST1E detector by pressing the pushbutton once. The peak can be cleared by pressing and holding the pushbutton for 3 seconds, after which the detector will return to the next screen.



## 4.11 Zero the Sensor

Over time and with usage, the sensor baseline may drift from the original baseline. To ensure optimal performance, WatchGas recommends zeroing the O<sub>2</sub> sensor once every 24 hours, or when the Automatic Zero Reminder is displayed for O<sub>2</sub> models.

## 4.12 Automatic Zero Reminder for O<sub>2</sub> Models

For **SST1/SST1E O<sub>2</sub> models exclusively**, the Automatic Zero Reminder appears when more than 24 hours have passed since the last successful zero procedure was conducted.

It is highly recommended that users perform a Zero Calibration when prompted by the Zero Reminder, in order to ensure accurate readings and optimal device performance.

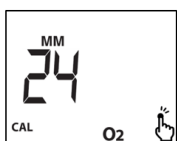

## 4.13 Zero Procedure

The Zero Procedure can be performed on SST1/SST1E O<sub>2</sub> (both detector and monitor mode) and toxic SST1/SST1E models (monitor mode only). Here's how to perform the Zero Procedure:

1. Transition to a standard atmosphere containing 20.9% v/v O<sub>2</sub>, ensuring it is free of hazardous gases.
2. Press and hold the pushbutton for 5 seconds until ZERO is displayed, indicating that the Zero Procedure has initiated.
3. Continue to hold down the pushbutton until the 10-seconds countdown has been completed.
4. Upon completion of the countdown, the Zero Procedure has been completed and the result will be displayed.
5. If the Zero Procedure is successful, "PASS" is displayed. The detector will return to measurement mode.
6. If the Zero Procedure fails, the detector will beep and flash the non-compliance LED. It will return to measurement mode, toggling FAIL and display the reading or months remaining. Non-compliance icons are displayed.
7. Repeat the Zero Procedure. For Toxic models, a failed Zero Calibration requires a successful Zero and Span Calibration. If the procedure fails again, contact WatchGas for further assistance.

Repeated failed Zero Calibration will **Lock the unit**.

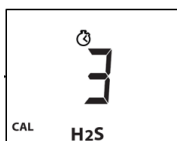
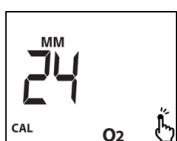

## 5. User Menu

The SST1/SST1E features a user menu that can be entered by pressing the pushbutton once. Upon pressing the pushbutton the next menu screen will be displayed in the following order:

### 5.1 Peak Reading



If the detector has measured a gas concentration above the alarm setpoint within the last 24 hours, the peak reading will be displayed.

Pressing and holding the pushbutton for 3 seconds will clear the peak.

Alternatively, the Peak can be cleared using WatchGas Device Link App or SST Dock.

### 5.2 Real-time Clock



When enabled, the detector will display its current time in a 24-hour format.

The Real-time Clock can be enabled/disabled using Single Device Setup.

Device time can be synchronized using WatchGas Device Link App.

### 5.3 Low Alarm



The detector will display its Low alarm setpoint.

### 5.4 High Alarm



The detector will display its High alarm setpoint.

## 5.5 Clear Peak

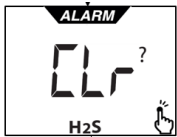

The Clear option allows users to clear Peak.

To initiate the Clear, press and hold the pushbutton for 5 seconds. When the data is cleared, the happy smiley icon will be displayed, indicating that the process is completed.

When the pushbutton is pressed again, the SST1/SST1E detector will return to measurement mode.

**NOTE:** the SST1/SST1E detector will automatically return to measurement mode if no pushbutton is pressed, or when a gas alarm occurs.

## 6. Communicating With the SST1/SST1E

The SST1/SST1E gas detector is equipped with Near Field Communication (NFC). NFC is used to communicate with:

- [WatchGas Device Link App](#)
- [WatchGas SST Dock](#)
- [WatchGas Compliance Kiosk](#)

The NFC chip is located on the back of the detector, under the alligator clip.

To activate NFC, press and hold the pushbutton for 3 seconds until the SST1/SST1E detector beeps once. The NFC icon is now displayed in the upper right corner of the device. The SST1/SST1E detector is now able to communicate with the WatchGas Device Link App, SST Dock, Compliance Kiosk, and WatchGas SST RTR Web Reporting Software.

The NFC will automatically deactivate after a period of 300 seconds.

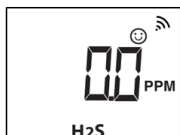

### 6.1 Communicating With the SST1 in Hibernation

While the SST1/SST1E detector is in Hibernation (turned off), the NFC communication can be activated by pressing and holding the pushbutton for 3 seconds. The SST1 detector will display SET, as well as the NFC icon.

The SET mode allows for configuration without the need for powering on the SST1/SST1E detector.

The NFC will automatically deactivate after 200 seconds, or by pressing the pushbutton once, after which the SST1/SST1E detector will return to hibernation.



## 7. WatchGas Device Link App

The [WatchGas Device Link App](#) can be used to communicate with the SST1/SST1E detector and verify detector compliance.

### 7.1 WatchGas Device Link App Main Screen

To connect the SST1/SST1E detector to the WatchGas Device Link App:

1. Press and hold the pushbutton for 3 seconds to activate NFC.
2. On the WatchGas Device Link App, press “Tap to activate NFC”.
3. Connect the NFC chip located on the back of the detector to the NFC antenna of the mobile phone.
4. Device Link will show “Compliant” when the SST1 detector is fully compliant.
5. If one or more items are non-compliant, the WatchGas Device Link App will show “Not Compliant” and indicate which item is non-compliant.

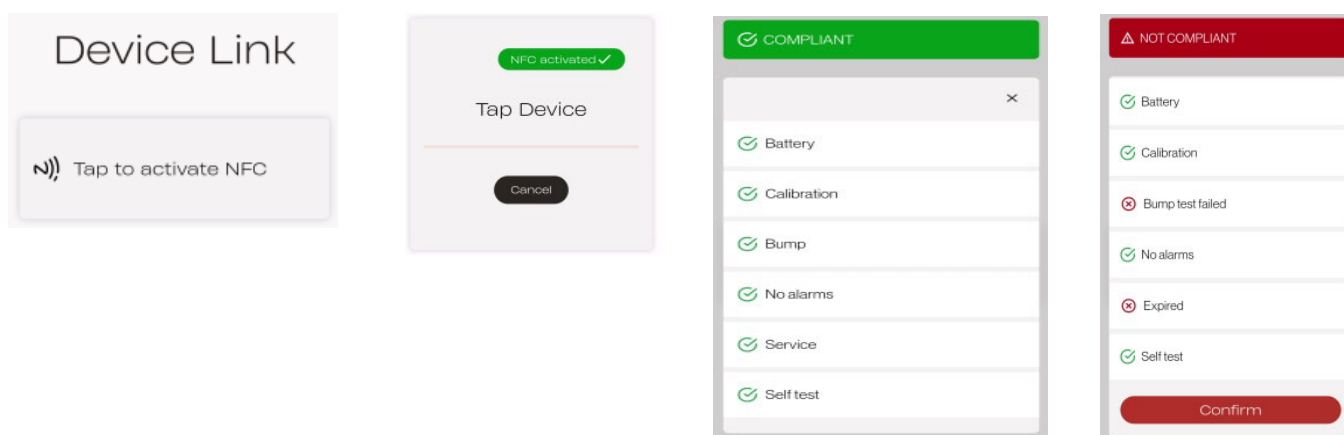

**NOTE:** Upon connecting with the WatchGas Device Link App, the Compliance Interval will be reset, Peak will be cleared, and the Event Log will be transferred.

### 7.2 WatchGas Device Link App Assign/Unassign Function

The SST1/SST1E detector can be designated to a specific user and site through the WatchGas Device Link App. Enabling the “Assign Check Function” in the Application Settings triggers the WatchGas Device Link App to prompt users to assign any unassigned SST1/SST1E detectors to a user and site.

When an unassigned SST1/SST1E connects to the WatchGas Device Link App, the user is prompted to input the User ID and Site information. Once entered, these settings can be transmitted to the SST1/SST1E using NFC, effectively assigning the User ID and Site to the detector in question.

The WatchGas Device Link App will skip the User ID assignment prompt if the detector already has a User ID assigned.

Alternatively, users can set the User ID and Site using the Single Device Setup feature, detailed in the [WatchGas Device Link App Single Device Setup section](#).



## 7.3 WatchGas Device Link App Single Device Setup

The Single Device Setup in the WatchGas Device Link App can be used to configure the SST1/SST1E detector.

The Single Device Setup can be accessed through the WatchGas Device Link App menu, with the password “service”.

This User Options section includes SST1/SST1E detector features that can be enabled or disabled. The green checkmark indicates that the option is enabled. Press the checkbox to disable the option.

### Device Identification

- **Model:** SST1/SST1E Model type
- **Sensor:** SST1/SST1E Sensor type
- **User ID:** User ID assigned to the detector.
- **Site ID:** Site assigned to the detector.
- **Serial number:** Detector serial number (non-changeable)
- **Firmware version:** Detector firmware version
- **First time on:** Date and time the detector has been switched on

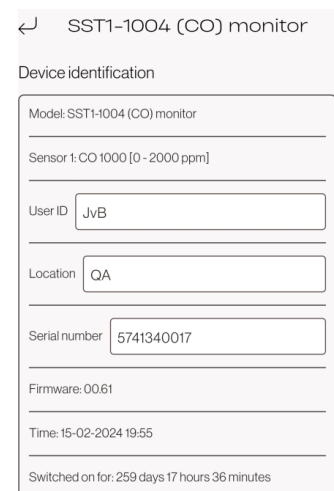

### Function Setting

- **Real Time Clock:** Switch on/off displaying the real-time clock on the detector.
- **Green Compliance:** If turned on, a compliant detector will flash a green LED every 5 minutes.
- **Self-test interval:** Interval after which the user is prompted to perform a manual self-test
- **Scan protect:** Enable NFC pin to protect the detector against connecting with an unauthorized WatchGas Device Link App
- **Simple Mode:** When enabled, this option hides the peak indicator and smiley icons from the screen display.
- **Silent Mode:** This function mutes sounds and turns off LED, and only uses the vibrator to indicate alarms.

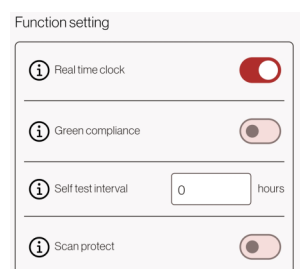

## Calibration

- **Enable Expiry:** Enable/disable calibration interval.
- **Calibration interval:** Calibration interval in days.



Calibration

Enable Expiry

Calibration Interval  days

## Bump

- **Enable Expiry:** Enable/disable calibration interval.
- **Calibration interval:** Calibration interval in days.
- **Bump speed:** Set % of gas applied required to pass bump test:

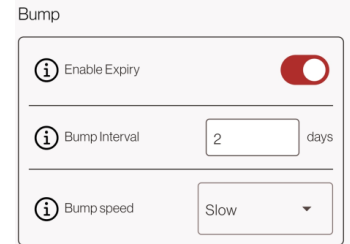

Bump

Enable Expiry

Bump Interval  days

Bump speed

- Fast: 50%
- Medium: 70%
- Slow: 90%

**NOTE:** the Bump speed setting does not change the allowed time for a bump test

## Sensor Settings

- **Sensor unit:** unit of measurement:
  - **ppm:** Parts per Million (default for toxic models)
  - **mg/m<sup>3</sup>:** Milligram per cubic meter (toxic models)
  - **µmol/mol:** Micromoles per mole (toxic models)
  - **vol%:** Volume percent (O<sub>2</sub> model only)
- **Alarm Low:** Low alarm setpoint
- **Alarm High:** High Alarm setpoint

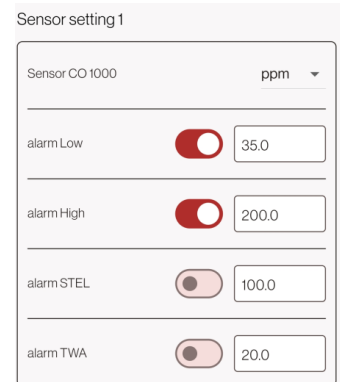

Sensor setting 1

Sensor CO 1000

alarm Low

alarm High

alarm STEL

alarm TWA

## Health Data

In the Single Device Setup, various parameters indicating detector health can be viewed:

- **Ppm\*hours:** accumulated gas exposure, indicating sensor health.
- **Peak reading:** All-time peak reading registered.
- **Factory calibration:** sensor output during factory calibration
- **Last calibration:** sensor output during last field calibration
- **Sensor SN:** Gas sensor serial number
- **Last calibration date:** Date on which the last successful calibration was performed
- **Last bump date:** Date on which the last successful bump test was performed.

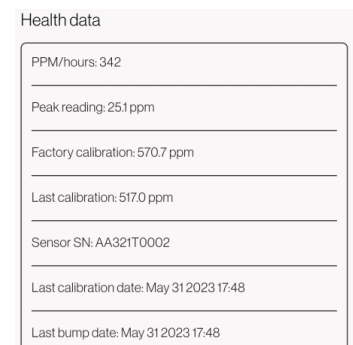

Health data

PPM/hours: 342

Peak reading: 25.1 ppm

Factory calibration: 570.7 ppm

Last calibration: 517.0 ppm

Sensor SN: AA321T0002

Last calibration date: May 31 2023 17:48

Last bump date: May 31 2023 17:48

## Unit Data

In Single Device Setup various parameters related to the detector can be viewed:

- **Min temp:** all-time minimum temperature
- **Max temp:** all-time maximum temperature
- **Battery SN:** battery serial number
- **Battery run time:** total battery runtime
- **Days on:** total time the SST1 detector has been switched on
- **In alarm:** total minutes the detector has been in alarm

Unit data
Switched on for 259 days 17 hours 36 minutes
Min. temp: 6.7 C° 44.1 F°
Max. temp: 39.7 C° 103.5 F°
Battery run time: 260 days 5 hours 38 minutes
Battery SN: FEB230068
In alarm: 3 minutes

## 7.4 WatchGas Device Link App Saved Configurations

Saved Configurations in the WatchGas Device Link App can be used to create saved configuration files that can be used to quickly and easily configure multiple detectors.

### Creating Saved Configuration Files

To create a saved configuration file:

1. Log in to the WatchGas Device Link App using password: service
2. Navigate to “Saved Configurations.”
3. Press the “+” icon.
4. Select the SST1 model.
5. Provide a file name and description.
6. Input the configuration settings.
7. Press the “Save” button.

File Function
File name
SST1-1004 (CO) monitor
Description
Default OSHA
 Use for compliance <input checked="" type="checkbox"/>

### Use For Compliance

By selecting this option, the WatchGas Device Link App will utilize the saved configuration file to verify detector alarm setpoints. When a detector with mismatched alarms is linked to the WatchGas Device Link App, the user will be prompted to adjust the alarm setpoints.

### Loading a Saved Configuration to the SST1 Detector

1. Log in to the WatchGas Device Link App using password: service
2. Access “Saved Configurations” and choose the desired configuration file.
3. Manually verify all settings for accuracy.

4. Press the “Save” button.
5. Press “Load settings to device.”
6. Activate NFC on the detector.
7. Connect the detector to the WatchGas Device Link App or Compliance Kiosk.



**NOTE:** Loading a saved configuration to an SST1/SST1E detector also functions when the detector is in SET mode, facilitating rapid configuration updates without requiring the detector to be powered on.

## 7.5 WatchGas Device Link App Unassign

The Unassign function can be used to unassign an SST1 detector. It will clear the User ID in the SST1/SST1E detector. Optionally, the Site ID can be cleared as well.

To unassign an SST1/SST1E detector:

1. In the WatchGas Device Link App, log in with password: service
2. Go to Unassign
3. Optional: select Unassign Site ID
4. Press “Tap to activate NFC”
5. Activate NFC on the detector
6. Connect the detector to the WatchGas Device Link App or Compliance Kiosk

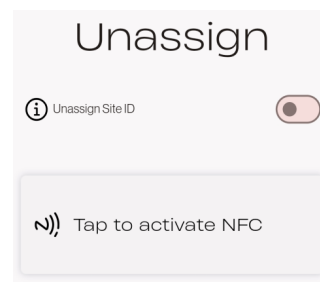

## 7.6 WatchGas Device Link App Hibernation

The Hibernation function can be used to (temporarily) turn off the SST1/SST1E detector.

To enter Hibernation:

1. In the WatchGas Device Link App, log in with password: service
2. Go to Hibernation
3. Press “Tap to activate NFC”
4. Activate NFC on the detector
5. Connect the detector to the WatchGas Device Link App or Compliance Kiosk

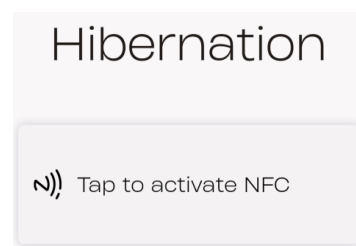

**WARNING:** An SST1/SST1E detector in Hibernation mode does not have a safety function and is unable to alarm its user when in hazardous atmosphere.

When a detector is turned on after being in Hibernation, sensor warm-up is required.

## 7.7 WatchGas Device Link App Maintenance

The Maintenance menu is used to diagnose and service the SST1/SST1E detector.

To enter Maintenance mode:

1. In WatchGas Device Link App, log in with password: service

2. Go to Maintenance

3. Press “Tap to activate NFC”

4. Activate NFC on the detector

5. Connect the detector to the WatchGas Device Link App or Compliance Kiosk

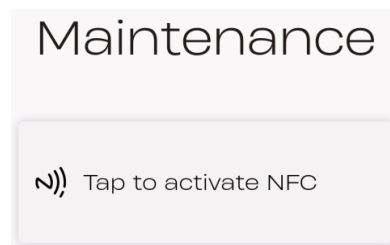

Upon connecting an SST1/SST1E detector to the Maintenance screen, the detector and component serial numbers are displayed.

Below each of the serial numbers, a star rating is displayed, indicating component health:

### Battery Health

Battery left %	Number of stars
> 50%	5
> 20%	4.5
> 15%	3
> 10%	1
< 10 %	0
Battery fault triggered	0

### Sensor Health

Counts/ppm %	Stars
> 60%	5
> 55%	4
> 50%	3
> 45%	2
> 40%	1
<= 40%	0.5
< 30%	0 (Calibration failed)

**NOTE:** Once a sensor fails calibration it needs to be replaced. To ensure good preventive maintenance WatchGas recommends to replace sensors at minimum 1 star. Refer to the [Sensor Replacement section](#) on how to do this.

## SST1/SST1E 2-3 Year Model Product Lifetime

Life left	Number of stars
>= 4 months	5
>= 3 months	3
>= 2 months	2
>= 45 days	1
>= 24 hours	0.5
< 24 hours	0

The Device serial number and PCB SN cannot be changed.

The Sensor SN and Battery SN can be changed using the “Edit” button.

Changing the Battery SN will reset the following health parameters:

- **Days on**
- **Battery run time**
- **In alarm**

Changing the Sensor SN will reset below health parameters:

- **Ppm\*hours**
- **Peak**
- **Factory calibration**
- **Last calibration**

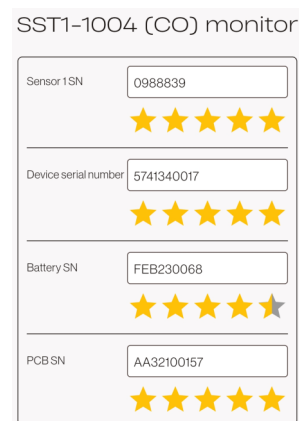

**NOTE:** When changing components, component serial numbers must be changed using WatchGas Device Link App Maintenance, refer to the [SST1 Maintenance section](#).

**WARNING:** Only substitute with original WatchGas parts. Substitution of parts always requires a full calibration prior to use.

## 7.8 Firmware Update

Refer to the [Firmware Update section](#).

## 8. Bump Test and Calibration

WatchGas recommends performing a bump test with a known concentration of gas above the alarm setpoints before each day of use. And, additionally, when a detector is subjected to physical damage, dirt/debris, immersion, under limit alarm, over limit alarm, or if detector performance is in doubt in any way.

To ensure the highest detection accuracy, WatchGas recommends frequent detector calibration.

WatchGas recommends using the SST Dock to perform bump tests and calibrations on the SST1/SST1E detector.

WatchGas recommends using calibration gas for both bump tests as well as calibrations as per the table below.

Sensor	Range	Calibration Gas	Calibration Time
SST1 CO	0 - 2000 ppm	100 ppm CO	90 seconds
SST1E CO	0 - 1500 ppm	100 ppm CO	90 seconds
SST1 H <sub>2</sub> S	0 - 500 ppm	25 ppm H <sub>2</sub> S	90 seconds
SST1E H <sub>2</sub> S	0 - 300 ppm	25 ppm H <sub>2</sub> S	90 seconds
SST1 O <sub>2</sub>	0 - 25 vol%	18 vol% O <sub>2</sub>	90 seconds
SST1E O <sub>2</sub>	0 - 25 vol%	18 vol% O <sub>2</sub>	90 seconds
SST1 SO <sub>2</sub>	0 - 100 ppm	10 ppm SO <sub>2</sub>	120 seconds
SST1E SO <sub>2</sub>	0 - 40 ppm	5 ppm SO <sub>2</sub>	180 seconds

**Table 5.** Calibration Gas ranges and time

WatchGas recommends using a stainless steel regulator with a fixed flow of 0.5 L/min, and non-absorbent tubing such as [Last-O-More](#).

### 8.1 Manual Bump Test

When no SST Dock is available, a manual bump test can be performed. To perform a Bump Test on the SST1/SST1E detector:

1. Transition to a standard ambient atmosphere with 20.9% oxygen concentration, free of any hazardous gases.
2. Log in using password: service
3. Navigate to “Bump Test.”
4. Optionally, add a new calibration gas cylinder.
5. Select the gas cylinder from the list.
6. Activate NFC on the SST1/SST1E detector.
7. Connect to the detector WatchGas Device Link App using NFC. A countdown timer will be displayed on both the SST1/SST1E detector and the WatchGas Device Link App.
8. Connect the gas to the detector using the original calibration cap.

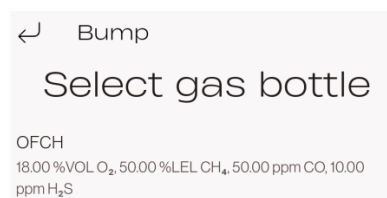

9. Start the flow of gas and wait for the Bump Test to finish.

10. Stop the flow of gas.

11. Connect the SST1/SST1E detector to the WatchGas Device Link App using NFC.

The Bump Test result is displayed. A successful Bump Test will reset the Bump Test Interval (if this option is enabled).

If the Bump Test fails, retry the test using the steps above.

If the Bump Test fails repeatedly, perform a Calibration. The SST1/SST1E detector will automatically lock after 10 consecutive failed Bump Tests.

**NOTE:** The SST1/SST1E detector shown on the WatchGas Device Link App is only a simulated example. The real Bump Test result must be viewed on the SST1/SST1E detector itself.



## 8.2 Manual Calibration

When no SST Dock is available, a manual Calibration can be performed. To perform a Calibration on the SST1/SST1E detector:

1. Transition to a standard ambient atmosphere with 20.9% oxygen concentration, free of any hazardous gases.
2. Log in using password: service
3. Navigate to “Calibration”
4. Optionally, add a new calibration gas cylinder.
5. Select the gas cylinder from the list.
6. Activate NFC on the SST1/SST1E detector.
7. Connect to the detector WatchGas Device Link App using NFC. The Fresh Air Calibration will start and a countdown time will be displayed

8. Wait for the Fresh Air Calibration to finish.
9. Connect the gas to the detector using the original calibration cap.
10. Start the flow of gas and wait for the span calibration to finish.
11. Stop the flow of gas.
12. Connect the SST1/SST1E detector to the WatchGas Device Link App using NFC.

The Calibration result is displayed. A successful Calibration will reset the Calibration and Bump Test Interval (if this option has been enabled).

A successful Calibration will generate a Calibration Certificate.

The user will be prompted to check the visual, audible, and vibration alarms, as well as to visually inspect the SST1/SST1E detector for any damage. The results of these checks must be entered into the WatchGas Device Link App. Additionally, the name of the person carrying out the calibration must be recorded.

Once these steps are completed, the generated Calibration Certificate can be viewed and shared by pressing the “Next” button.

If the Calibration fails, retry the test using the steps above.

If the Calibration fails repeatedly, contact WatchGas. The detector will automatically lock after 10 consecutive failed Calibrations.

**NOTE:** The SST1/SST1E detector shown on the WatchGas Device Link App is only a simulated example. The real Calibration result must be viewed on the SST1 detector itself.

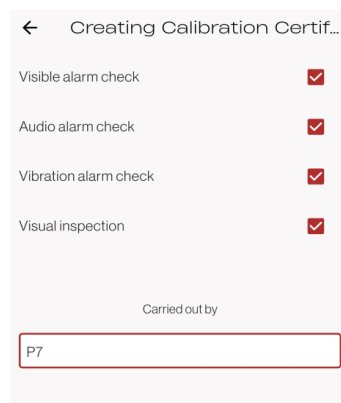
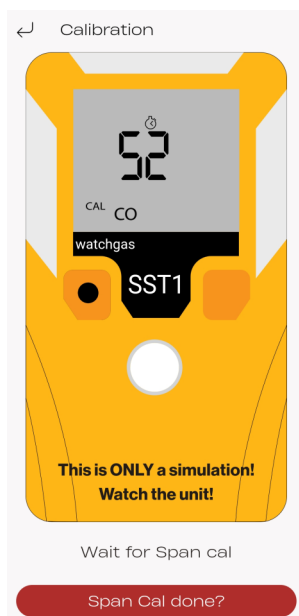

## 9. Logs

### 9.1 Event Logs

The detector records the 100 most recent gas alarm events. The following information is recorded:

- Serial number of the detector
- Start time of the alarm
- Type, level, and duration of the alarm
- Peak exposure level (ppm or %), STEL, TWA, including calculate average (Monitor mode only)
- Clearing Alarms
- Bump test results
- Calibration results
- Compliance checks, including instances where a non-compliant detector is confirmed by the Device
- Link User
- Status of the sensors

**NOTE:** Event logs cannot be cleared from the WatchGas Device Link App.

### 9.2 Downloading Event Logs

The event log files can only be downloaded by means of an SST Dock or the WatchGas Device Link App. To share event logs:

1. Log in using password: user
2. Go to “Event Logs”
3. Select the Event Log file to export (**NOTE:** multiple Event Log files can be selected)
4. Press “Share”
5. Select app to share the Event Log(s) to

**NOTE:** When the WatchGas SST RTR Web Reporting Software is activated, event logs are automatically shared to it.

## 9.3 IOELV and Daily Peaks

To view all IOELV (indicative occupational exposure limit values) and daily peaks on all SST1/SST1E units, navigate to IOELV and Daily Peaks in the WatchGas Device Link App.

**NOTE:** To ensure accurate reporting, the SST1/SST1E unit should be tapped with a WatchGas Device Link App or SST Dock at least once every 5 days.

Select an SST1/SST1E unit from the list. Users can also filter units by type and search for specific units.

Note that users can also share these by pressing the Share button at the bottom of the screen.

## 9.4 Changelogs

To view all changes made to unit settings, navigate to Changelogs in the WatchGas Device Link App.

Select an SST unit from the list.

These logs are stored per unit, and they consist of the following categories:

1. **Single Device Setup** - Any adjustments made to Settings.
2. **Saved Configuration File (SCF)** - Setting changes file.
3. **Use for Compliance** - Same as the SCF, used for compliance purposes.
4. **Maintenance** - Service-related information.
5. **Assign** - Tracks assignment of a user and (optionally) site ID.
6. **Unassign** - Tracks removal of a user and (optionally) site ID.

## 10. Firmware Upgrade

WatchGas recommends using the latest detector firmware for optimal performance and functionality.

The latest firmware is automatically available in the WatchGas Device Link App or the SST Dock.

To upgrade firmware on the SST1/SST1E detector:

1. Log in using password: service (**NOTE:** factory default password, can be changed)
2. Navigate to “Firmware upgrade”
3. Select the correct firmware version and model.
4. Activate NFC on the detector
5. Connect the SST1/SST1E detector to the WatchGas Device Link App, ensuring that the connection is not lost.
6. Wait for the NFC file transfer to finalize. This may take several minutes. The SST1/SST1E will then reboot upon receiving the firmware file.
7. Verify detector settings in Single Device Setup.

**NOTE:** After conducting a firmware upgrade, it is essential to always perform a configuration check and full calibration of the SST1/SST1E to ensure the system is functioning properly.

## 11. Troubleshooting

Problem	Possible Cause	Solution
Time set incorrectly	Time not synchronized	Connect the detector to the Watch-Gas Device Link App, Compliance Kiosk, or SST Dock.
Manual zero calibration fails	Sensor drift	Perform a full calibration.
Bump test fails repeatedly	Filter dirty (internal or external)	Replace filter.
	Sensor drift	Perform a full calibration.
Detector displays FAIL/Err2 after warm-up	Sensor insufficiently stabilized	Put the detector in Hibernation mode, then start it again.
		Perform a full calibration once warm-up has completed.
Detector shows ▲ and ☹️, but no error message/icon is displayed	The compliance interval has been exceeded	Connect the detector to the Watch-Gas Device Link App, Compliance Kiosk, or SST Dock to reset its compliance interval.

**Table 6.** Troubleshooting

**NOTE:** This troubleshooting guide assumes that the SST1/SST1E detector runs on the latest firmware version.

Refer to the [Firmware Upgrade section](#) on how to upgrade the SST1/SST1E firmware version.

## 12. Failure Codes

In the table below, you can find all the failure codes, their most common causes, and how to resolve them:

Code	Reason	Action
BAT	Battery voltage too low	Replace battery
CAL	Calibration fail	Perform successful calibration
Buñp	Bump Test fail	Perform successful bump test
TEST	Self-test fail	Perform manual self-test
EOL	Detector life expired (>1 month)	Replace detector
P01	Configuration error	Reconfigure unit, contact WatchGas
OL and -OL	Sensor negative drift	Zero calibrate

**Table 7.** Failure Codes

When a fault arises in the SST1/SST1E, the detector will remain operational. The non-compliance signals will promptly alert the user to the issue. Additionally, certain faults may activate the audible alarm to further draw attention to the situation.

Repeated faults will result in the SST1/SST1E being locked. A locked SST1/SST1E is rendered inoperable and must be handled by authorized personnel, or taken to a WatchGas Service Center for servicing.

To power off a locked SST1/SST1E detector, simply press the pushbutton once.

A locked SST1/SST1E detector can be unlocked using the WatchGas Device Link App Maintenance, refer to the [Unlocking the SST1/SST1E Detector section](#).

Furthermore, the Lock or Fault state can be observed in WatchGas Device Link App Maintenance.



## 13. Unlocking the SST1/SST1E Detector

### 13.1 Unlock

When the SST1/SST1E is locked, maintenance is required. Refer to the [SST1/SST1E Maintenance section](#).

An SST1/SST1E detector that has been locked because its activation time has expired can be unlocked by pressing the “Unlock” button.

Service personnel must assess the battery condition by star rating and total minutes in alarm. If the battery’s lifespan cannot be guaranteed for the additional detector lifetime, the battery must be replaced.

**NOTE:** The permitted extra lifetime is 12 months.

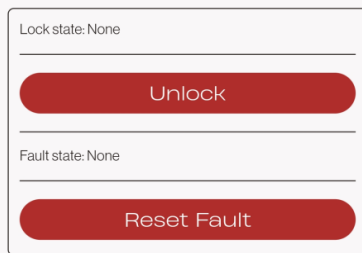

### 13.2 Reset Fault

After performing the necessary maintenance, a failed SST1/SST1E unit can be unlocked by pressing the “Reset Fault” button.

**NOTE:** Unlocking an SST1/SST1E unit without proper maintenance may void its safety function and/or intrinsic safety.

## 14. SST1/SST1E Spare Parts and Accessories Lists

**NOTE:** SST1/SST1E detector maintenance may only be performed by trained/authorized individuals and/or service center personnel.

**NOTE:** SST1/SST1E parts may only be replaced by original WatchGas parts, as per the spare parts lists table. Substitution of parts may impair detector function and intrinsic safety.

Part Number	Description
<b>SST1-BAT</b>	WatchGas SST1 Replacement Battery - 3.6V
<b>SST1-BAT-10</b>	WatchGas SST1 Replacement Battery - 3.6V pack of 10
<b>SST-AG-10</b>	WatchGas SST Range Replacement Alligator Clip with screw pack of 10
<b>SST1-CALCAP-10</b>	WatchGas SST1 Calibration Cap (pack of 10)

**Table 8.** SST1 Spare Parts and Accessories List

Part Number	Description
<b>SST1-FC-Y-E</b>	WatchGas SST1E Replacement Front Case - Yellow
<b>SST1-FILTER-E-50</b>	WatchGas SST1E Internal Filter pack of 50
<b>SST1-ORING-E-50</b>	SST1E O-ring pack of 50

**Table 9.** SST1E Spare Parts and Accessories List

Part Number	Description	Range
<b>SST-SPARE-H</b>	WatchGas SST sensor H <sub>2</sub> S 0-500 ppm for All (Hydrogen Sulfide)	0-500 ppm
<b>SST-SPARE-M</b>	WatchGas SST sensor CO 0-2000 ppm for All (Carbon Monoxide)	0-2000 ppm
<b>SST-SPARE-O</b>	WatchGas SST sensor O <sub>2</sub> 0-25%vol. for All (Oxygen)	0-25% vol
<b>SST-SPARE-S</b>	WatchGas SST sensor SO <sub>2</sub> 0-100 ppm for All (Sulfur Dioxide)	0-100 ppm

**Table 10.** SST1 Spare Sensors List

Part Number	Description	Range
<b>SPARE-H-E</b>	WatchGas SST sensor H <sub>2</sub> S 0-300 ppm for SST1E (Hydrogen Sulfide)	0-300 ppm
<b>SPARE-M-E</b>	WatchGas SST sensor CO 0-1500 ppm for SST1E (Carbon Monoxide)	0-1500 ppm
<b>SPARE-O-E</b>	WatchGas SST sensor O <sub>2</sub> 0-25%vol for SST1E (Oxygen)	0-25% vol
<b>SPARE-S-E</b>	WatchGas SST sensor SO <sub>2</sub> 0-40 ppm for SST1E (Sulfur Dioxide)	0-40 ppm

**Table 11.** SST1E Spare Sensors List

## 14.1 Detector Accessories – External Filter

**NOTE:** Only original WatchGas parts may be used as SST1/SST1E detector accessories. Substitution of parts may impair detector function and intrinsic safety.

WatchGas strongly recommends utilizing an external filter in applications where dust, dirt, or other debris may be present.

When using an external filter, always ensure that there are no obstructions between the atmosphere and the gas sensor. Regular filter changes are highly recommended to maintain optimal performance.

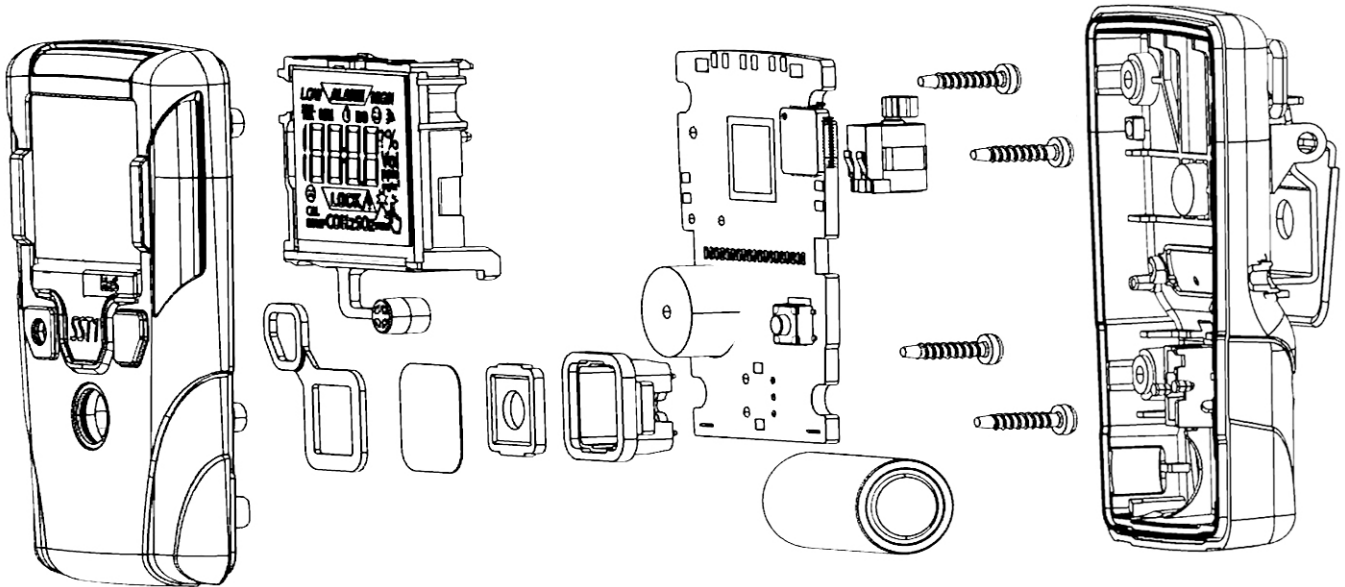

Figure 8. SST1 exploded view

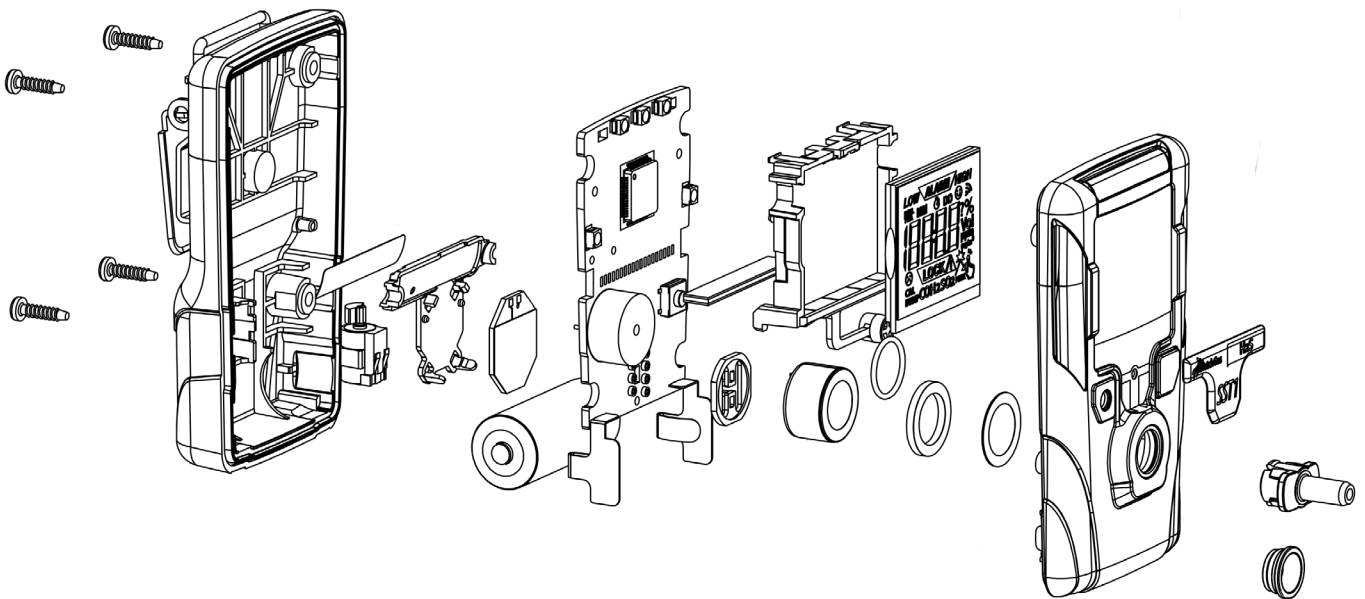

Figure 9. SST1E exploded view

## 15. SST1/SST1E Maintenance

### 15.1 Detector Maintenance – Battery Replacement

**NOTE:** the SST1/SST1E battery is non-user replaceable. The battery may only be replaced by authorized personnel and/or WatchGas service centers.

To replace the SST1/SST1E battery:

1. Turn off the unit by selecting Hibernation mode in the WatchGas Device Link App.
2. Use a PH00 screwdriver to loosen the four screws on the back of the unit by turning them counter-clockwise, then carefully separate the housing parts.
3. Remove the old battery from the unit. Dispose of the battery as per local regulations.
4. Note the battery batch code for the new battery.
5. Insert the new battery, ensuring that the positive (+) and negative (-) terminals align correctly with the indicators on the unit.
6. Carefully reattach the back cover.
7. Secure the unit by tightening the four screws on the back using a PH00 screwdriver, applying 0.7 N/m torque, and turning the screws clockwise.
8. In the WatchGas Device Link App Maintenance, input the battery batch code. If the unit is locked, unlock it.
9. Perform Calibration on the unit before putting it back into use.

**NOTE:** Changing the Battery SN will reset the following health parameters:

- Switched on for
- Battery run time
- In alarm

### 15.2 Detector Maintenance – Internal Filter Replacement

To replace the SST1/SST1E Internal Filter:

1. Turn off the unit by selecting Hibernation mode in the WatchGas Device Link App.
2. Use a PH00 screwdriver to loosen the four screws on the back of the unit by turning them counter-clockwise, then carefully separate the housing parts.
3. Replace the internal filter
4. Carefully reattach the back cover.
5. Secure the unit by tightening the four screws on the back using a PH00 screwdriver, applying 0.7 N/m

torque, and turning the screws clockwise.

6. Perform calibration on the unit before putting it back into use.

## 15.3 Detector Maintenance – Sensor Replacement

To replace the SST1/SST1E gas sensor:

1. Turn off the unit by selecting Hibernation mode in the WatchGas Device Link App.

2. Use a PH00 screwdriver to loosen the four screws on the back of the unit by turning them counter-clockwise, then carefully separate the housing parts.

3. Replace the sensor. Note down the new sensor SN.

4. Carefully reattach the back cover.

5. Secure the unit by tightening the four screws on the back using a PH00 screwdriver, applying 0.7 N/m torque, and turning the screws clockwise.

8. In the WatchGas Device Link App Maintenance, enter the new sensor SN. Input the settings into the SST1 detector.

9. Perform Calibration on the unit before putting it back into use.

**NOTE:** Changing the Sensor SN will reset the following health parameters:

- Ppm\*hours
- Peak

## 16. Certifications and Approvals

### Intrinsic Safety:

II 1G Ex ia IIC T4 Ga

I M1 Ex ia I Ma

IECEX EXV 22.0030X ExVeritas 22ATEX1314X

ExVeritas 22UKEX1315X

EU conformity [www.watchgas.com](http://www.watchgas.com)

RoHS compliant

### Standard

IEC 60079-11:2013

IEC 60079-0:2020

EN IEC 60079-0:2018

EN 60079-11:2012

EN 50270:2015+AC:2016

### Inmetro:

CPEX 23.1066X

ABNT NBR IEC 60079-11:2013

ABNT NBR IEC 60079-0:2020

### North America:

UL 60079-0 7th Edition

UL 60079-11 6th Edition

CSA C22.2 NO. 60079-0:19

CAN/CSA C22.2 NO. 60079-11:14

UL 61010-1 Safety Requirements

CAN/CSA-C22.2 NO. 61010-1-12/A1:18

Low Voltage Directive 2014/35/EU

EMC Directive 2014/30/EU

CII, Zn O, AEx ia IIC T4 Ga

Int.Safe: CII Dv 1, Gr A,B,C,D T4

-40°C ≤ Tamb ≤ +60°C

### KTL:

25-AV4BO-0302X

적용규격: 방호장치 안전인증 고시 2021-22호

설치에 관한 모든 사항은 KS C IEC 60079-14를 따라야 한다.

### PESO:

Approval No: A/P/HQ/MH/104/8564 (P639849)

## 17. Contact Details

### EMEA

Klaverbaan 121  
2908 KD Capelle a/d IJssel  
The Netherlands

[info@watchgas.com](mailto:info@watchgas.com)  
[www.watchgas.com](http://www.watchgas.com)

### Americas

313 N. State Hwy 342  
Red Oak, TX 75154, USA

[info@watchgasusa.com](mailto:info@watchgasusa.com)  
[www.watchgasusa.com](http://www.watchgasusa.com)

### APAC

Woods Square Tower 1,  
12 Woodlands Square,  
#11-71, Singapore 737715

[info@watchgas.com](mailto:info@watchgas.com)  
[www.watchgas.com](http://www.watchgas.com)

### ANZ

Unit 5, 11 Brand Drive Thomastown,  
Victoria 3074 Australia

[aus@watchgas.com](mailto:aus@watchgas.com)

### SERVICE CENTERS:

**EMEA:** [servicesupportemea@watchgas.com](mailto:servicesupportemea@watchgas.com)

**APAC:** [servicesupportapac@watchgas.com](mailto:servicesupportapac@watchgas.com)

**NSAM:** [servicesupportnsam@watchgas.com](mailto:servicesupportnsam@watchgas.com)

**ANZ:** [servicesupportanz@watchgas.com](mailto:servicesupportanz@watchgas.com)